



REBEL P10

ATX 3.1 Power Supply Unit

Manual

Safety Instructions

This device is only to be used as a power supply unit for powering PCs and is intended exclusively for this purpose. Even when it is not being used for a long period of time, a power supply unit can still possess a high electric charge. For your own safety, be sure to follow the instructions below before using the device. The manufacturer's guarantee will become void if damage occurs to the product as a result of improper use or non-compliance with the following safety instructions.

CAUTION!

- Only use the device with accessories approved by the manufacturer and do not unscrew or modify the device without the manufacturer's consent. Repairs must only be carried out by authorized specialist personnel.
- Do not use the device in extreme environments. Also make sure that it always has sufficient distance to household heating appliances and radiators and other such sources of heat.
- Do not insert any objects into the openings of the device.
- The device is only intended for indoor use and within the appropriate level of humidity. Keep liquids away from the device and do not touch it with wet hands.
- Immediately disconnect the device from your household electricity supply if it comes into contact with liquid, or if smoke occurs, or if you notice any damage, for example, to the cables. Do not then use the device again.
- Only the outside of the power supply unit may be cleaned and only using a dry cloth. Before doing this, completely disconnect the device from your household electricity supply by pressing the power switch to "O" and pulling the plug of the power cord out of your wall outlet.

Specifications

General	550W	650W	750W	850W
■ Certifications	Cybenetics Silver	Cybenetics Bronze/ Silver 230 V	Cybenetics Silver	Cybenetics Silver
■ Form Factor	ATX 3.1	ATX 3.1	ATX 3.1	ATX 3.1
■ Continuous Power	550 W	650 W	750 W	850 W
■ ErP Compliant	✓	✓	✓	✓
■ Technology	DC/DC	DC/DC	DC/DC	DC/DC
■ MTBF	Min. 100,000 Hours	Min. 100,000 Hours	Min. 100,000 Hours	Min. 100,000 Hours
■ Operating Temperature	0 to +40 °C	0 to +40 °C	0 to +40 °C	0 to +40 °C
■ Standby Power Consumption	Max. 0.25 W	Max. 0.25 W	Max. 0.25 W	Max. 0.25 W
■ Weight without Cables	1.47 kg	1.50 kg	1.66 kg	1.74 kg
■ Dimensions (L x W x H)	140 x 150 x 86 mm	140 x 150 x 86 mm	140 x 150 x 86 mm	140 x 150 x 86 mm
■ Housing Color	Black	Black	Black	Black

Input

■ Voltage	100 – 240 VAC	100 – 240 VAC	100 – 240 VAC	100 – 240 VAC
■ Frequency	50 – 60 Hz	50 – 60 Hz	50 – 60 Hz	50 – 60 Hz
■ Input Current (110/230 V)	8 A / 4 A	8 A / 4 A	9 A / 4.5 A	10 A / 5 A

Output

■ 12 V Rail(s)	1	1	1	1
■ Load 3.3 V	18 A	18 A	18 A	18 A
■ Load 5 V	18 A	18 A	18 A	18 A
■ Max. Combined Power 3.3 V + 5 V	100 W	100 W	100 W	100 W
■ Load 12 V1	45.8 A	54.1 A	62.5 A	70.8 A
■ Max. Combined Power 12 V	549.6 W	649.2 W	750 W	849.6 W
■ Load 5 VSB	3 A	3 A	3 A	3 A
■ Load -12 V	0.3 A	0.3 A	0.3 A	0.3 A

Cable and Connectors

■ Cable Configuration	Fixed	Fixed	Fixed	Fixed
■ Flat Cables	✓	✓	✓	✓
■ Maximum Cable Length	73 cm	73 cm	73 cm	73 cm
■ Length of Mainboard Cable	55 cm	55 cm	55 cm	55 cm
■ Length of CPU Cable	62 cm	62 cm	62 cm	62 cm
■ Length of PCIe Cable	56 cm + 15 cm	56 cm + 15 cm	56 cm + 15 cm	56 cm + 15 cm
■ Cable Length to First Peripheral	48 cm	48 cm	48 cm	48 cm
■ 24-Pin Mainboard Connector	1	1	1	1
■ 4+4-Pin CPU Connector	1	1	2	2
■ 6+2-Pin PCIe Connector	2	2	4	4
■ SATA Connector	4	5	5	5
■ IDE Connector	1	1	1	1

Fan

■ Fan Size	120 mm	120 mm	120 mm	120 mm
■ Bearing Type	Sleeve Bearing	Sleeve Bearing	Sleeve Bearing	Sleeve Bearing

Safety Standards

■ CE	✓	✓	✓	✓
■ FCC	✓	✓	✓	✓
■ CB	✓	✓	✓	✓

Package Contents

■ Rebel P10 550/ 650/ 750/ 850, Power Cord, Mounting Screws

Safety Standards and Protections

This power supply unit is designed for a household power voltage of 100–200 volts. It complies with CE, FCC and CB safety standards and is equipped with protection features that are designed to protect the device itself as well as the components connected to it. The device will unexpectedly shut down in the event of a protection function. You should then check immediately if there is a specific cause for the shutdown.

OPP (Over-Power Protection)

If the system demands more power than the specifications allow, the power supply unit will switch itself off to protect the electronics from damage.

OVP (Over-Voltage Protection) / UVP (Under-Voltage Protection)

This function shuts off the power supply unit to protect the components as soon as the internal voltage exceeds or falls below the specified limits.

SCP (Short-Circuit Protection)

Should a short circuit occur, the SCP function switches off the power supply unit and protects the electronics from damage.

OCP (Over-Current Protection)

If the current measured on a rail exceeds a specified value, the OCP function switches off the power supply unit to prevent damage.

OTP (Over-Temperature Protection)

If the heat level inside the power supply unit reaches a critical point, the OTP function switches off the device to protect the electronics.

Installation

Remove the old power supply unit from the PC case

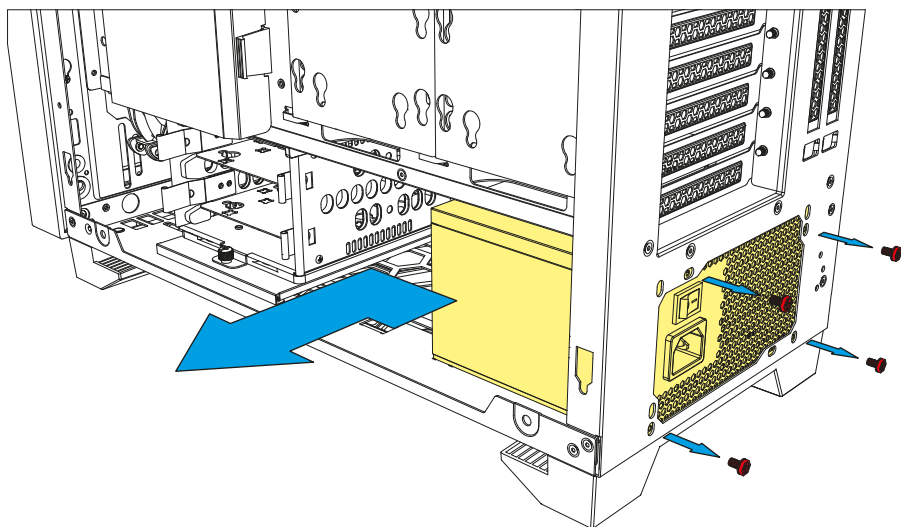
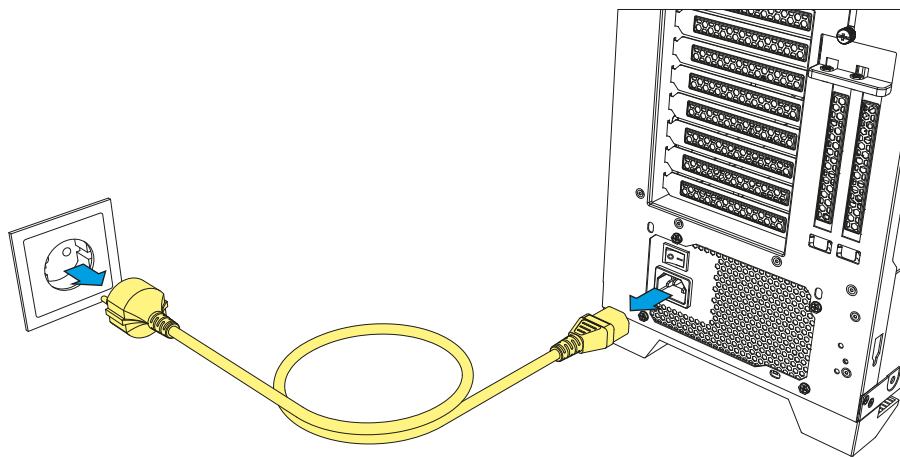

Installation

Install the power supply unit into the PC case

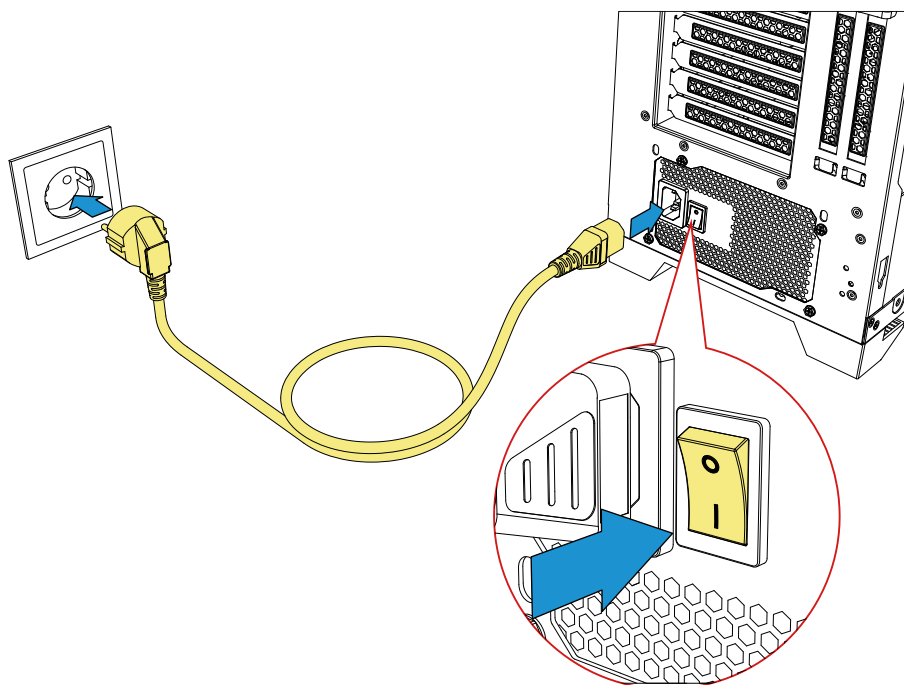
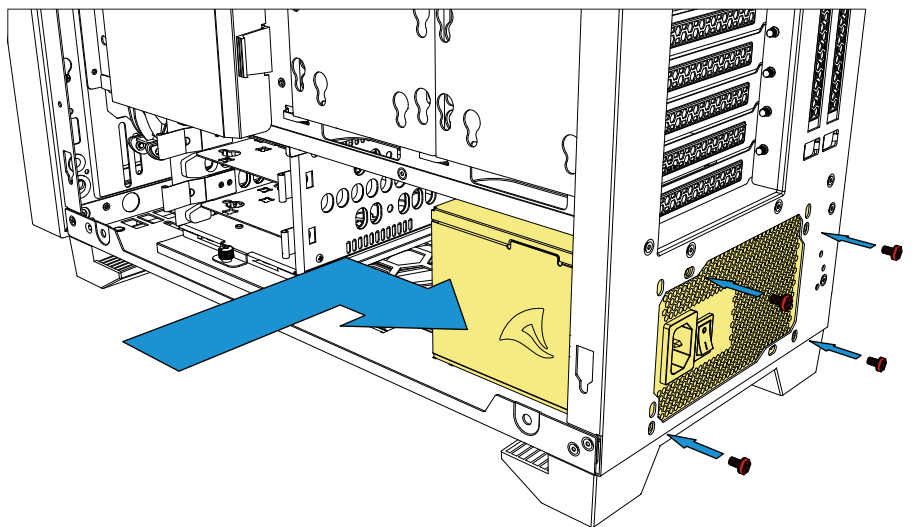

Rebel P10 550W

CABLE SET

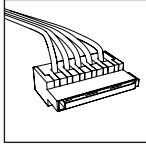
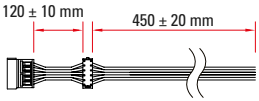
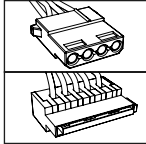
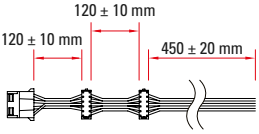
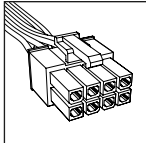
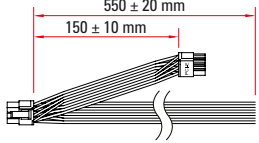
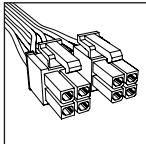
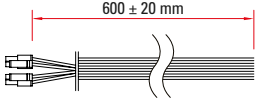
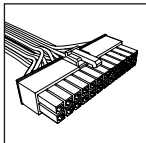
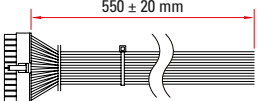
QTY	Type	Connectors per Cable	Cable
1	SATA Connector	2	 
1	IDE Connector	1	 
	SATA Connector	2	
1	6+2-Pin PCIe Connector	2	 
1	4+4-Pin CPU Connector	1	 
1	24-Pin Mainboard Connector	1	 

Rebel P10 650W

CABLE SET

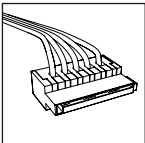
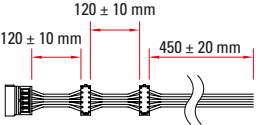
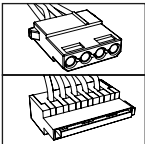
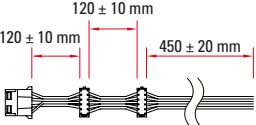
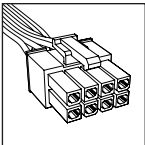
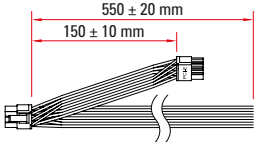
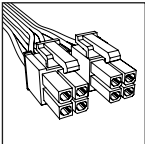
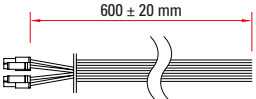
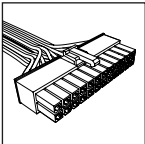
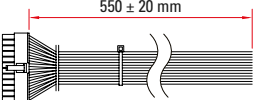
QTY	Type	Connectors per Cable	Cable
1	SATA Connector	3	 
1	IDE Connector	1	 
	SATA Connector	2	
1	6+2-Pin PCIe Connector	2	 
1	4+4-Pin CPU Connector	1	 
1	24-Pin Mainboard Connector	1	 

Rebel P10 750W / 850W

CABLE SET

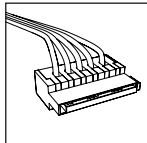
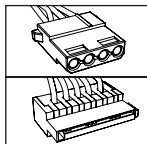
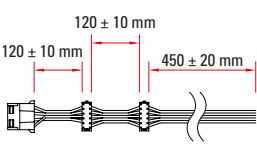
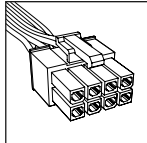
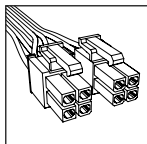
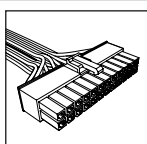
QTY	Type	Connectors per Cable	Total Connectors	Cable
1	SATA Connector	3	3	 <p>Diagram showing a SATA connector cable with dimensions: 120 ± 10 mm for the connector length, 120 ± 10 mm for the first cable segment, and 450 ± 20 mm for the total cable length.</p>
2	IDE Connector	1	2	 <p>Diagram showing an IDE connector cable with dimensions: 120 ± 10 mm for the connector length, 120 ± 10 mm for the first cable segment, and 450 ± 20 mm for the total cable length.</p>
	SATA Connector	2	4	 <p>Diagram showing a SATA connector cable with dimensions: 120 ± 10 mm for the connector length, 120 ± 10 mm for the first cable segment, and 450 ± 20 mm for the total cable length.</p>
2	6+2-Pin PCIe Connector	2	4	 <p>Diagram showing a 6+2-Pin PCIe connector cable with dimensions: 550 ± 20 mm for the total cable length and 150 ± 10 mm for the connector length.</p>
1	4+4-Pin CPU Connector	1	1	 <p>Diagram showing a 4+4-Pin CPU connector cable with a total length of 600 ± 20 mm.</p>
1	24-Pin Mainboard Connector	1	1	 <p>Diagram showing a 24-Pin Mainboard connector cable with a total length of 550 ± 20 mm.</p>

Troubleshooting

If the power supply unit is not functioning correctly, check the following points:

1. Is the power cord correctly inserted into your wall outlet and the power supply unit?
2. Make sure the on/off switch is in the “I” position.
3. Check that the 24-pin mainboard connector and the 4+4-pin CPU connector are correctly connected to the mainboard.
4. Check if the connectors of the cables are firmly plugged into the ports and headers of the peripheral hardware.
5. Pull the plug of the power cord out of your wall outlet and leave the power supply unit without power for approximately 10 minutes. This will cause a reset of the protective circuits.

If the system still fails to function, please contact support@sharkoon.com

Legal Disclaimer

For potential loss of data, especially due to inappropriate handling, Sharkoon assumes no liability.

All named products and descriptions are trademarks and/or registered trademarks of the respective manufacturers and are accepted as protected. As a continuing policy of product improvement at Sharkoon, the design and specifications are subject to change without prior notice. National product specifications may vary.

All rights reserved especially (also in extracts) for translation, reprinting, reproduction by copying or other technical means. Infringements will lead to compensation. All rights reserved especially in case of assignment of patent or utility patent. Means of delivery and technical modifications reserved.

Disposal of your old products

Your product is designed and manufactured with high quality materials and components, which can be recycled and reused.



When this crossed-out wheeled bin symbol is attached to a product, it means the product is covered by the European Directive 2012/19/EU.

Please be informed about the local separate collection system for electrical and electronic products. Please act according to your local rules and do not dispose of your old products with your normal household waste. The correct disposal of your old product will help prevent potential negative consequences to the environment and human health.

Follow us on social media!



Facebook



Instagram



YouTube



TikTok



X

Sharkoon Technologies GmbH

Grüninger Weg 48

35415 Pohlheim

Germany

© Sharkoon Technologies 2025

